

MİMARİ KATALOG
ARCHITECTURAL CATALOGUE

Alüminyum Kapı Pencere ve Giydirme Cephe Sistemleri
Aluminium Window Doors and Facade Systems



REFL40

MİMARİ KATALOG
ARCHITECTURAL CATALOGUE

Alüminyum Kapı Pencere ve Giydirme Cephe Sistemleri
Aluminium Window Doors and Facade Systems



REFL40



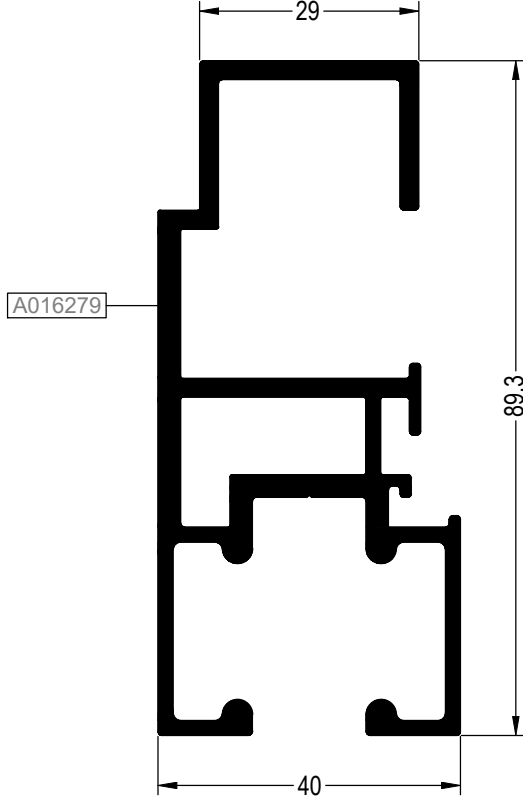

PROFİLLER

PROFILES

RAY PROFİLLERİ
RAIL PROFILES





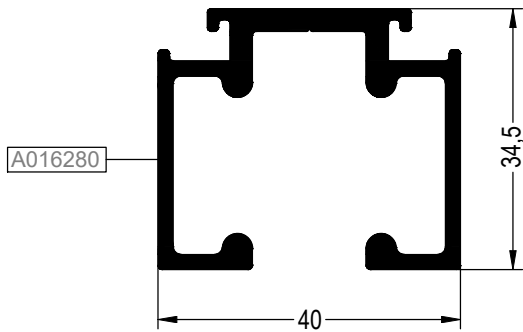

REFL 6001

	AĞIRLIK WEIGHT (kg/m)	1,996
	MALZEME MATERIAL	Alüminyum
	UZUNLUK LENGTH (m)	6
	Jx (cm ⁴)	13,416
	Jy (cm ⁴)	52,227





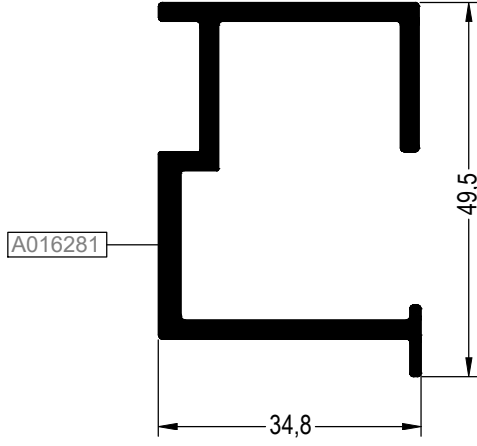

REFL 6002

	AĞIRLIK WEIGHT (kg/m)	0,915
	MALZEME MATERIAL	Alüminyum
	UZUNLUK LENGTH (m)	6
	Jx (cm ⁴)	6,595
	Jy (cm ⁴)	4,949





RAY PROFİLİ
RAIL PROFILE

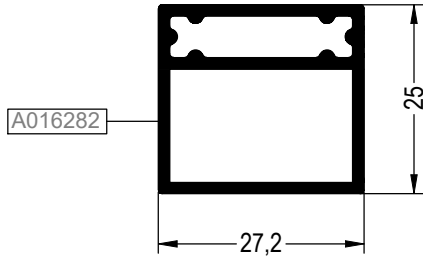

REFL 6003		
	AĞIRLIK WEIGHT (kg/m)	0,945
	MALZEME MATERIAL	Alüminyum
	UZUNLUK LENGTH (m)	6
	Jx (cm ⁴)	5,262
	Jy (cm ⁴)	10,252

KANAT PROFİLİ
VENT PROFILE



REFL 2001		
	AĞIRLIK WEIGHT (kg/m)	0,524
	MALZEME MATERIAL	Alüminyum
	UZUNLUK LENGTH (m)	6
	Jx (cm ⁴)	1,864
	Jy (cm ⁴)	1,512

MİMARİ KATALOG
ARCHITECTURAL CATALOGUE

Alüminyum Kapı Pencere ve Giydirme Cephe Sistemleri
Aluminium Window Doors and Facade Systems



REFL40

DETAYLAR

DETAILS

SİSTEM TİPOLOJİ
SYSTEM TYPOLOGY

FS01

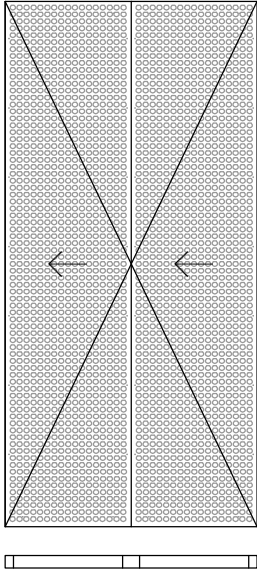

FS03

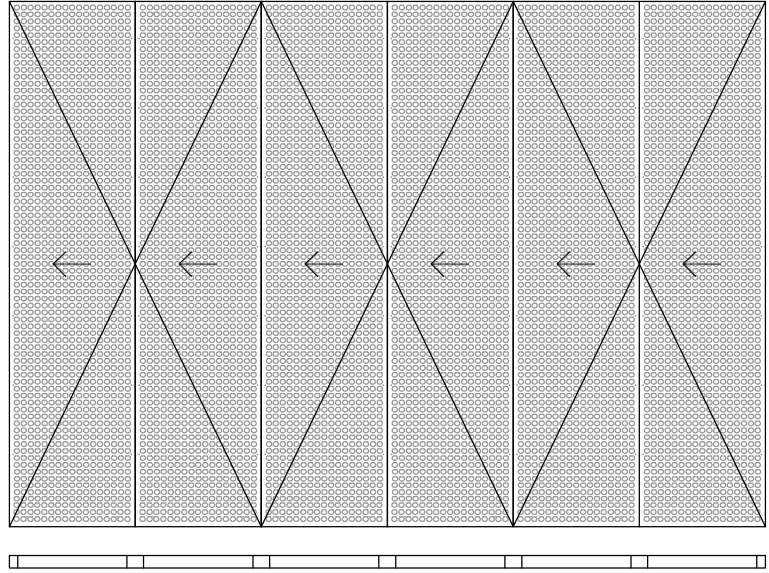

FS02

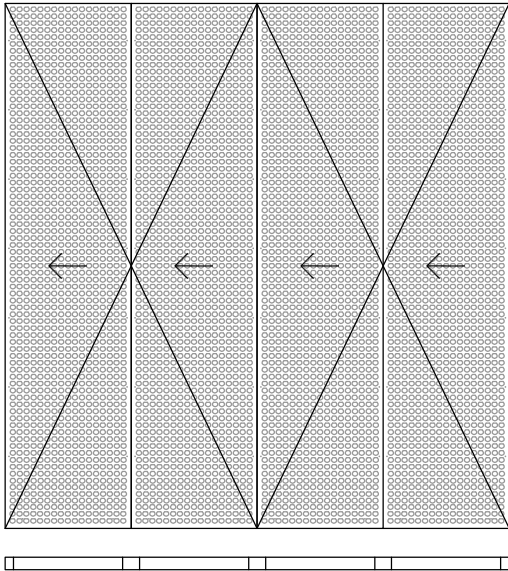

FS04

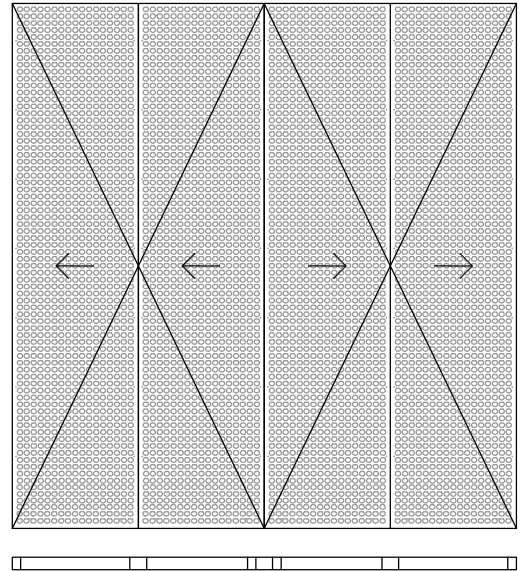

SİSTEM DETAYLARI
SYSTEM DETAILS

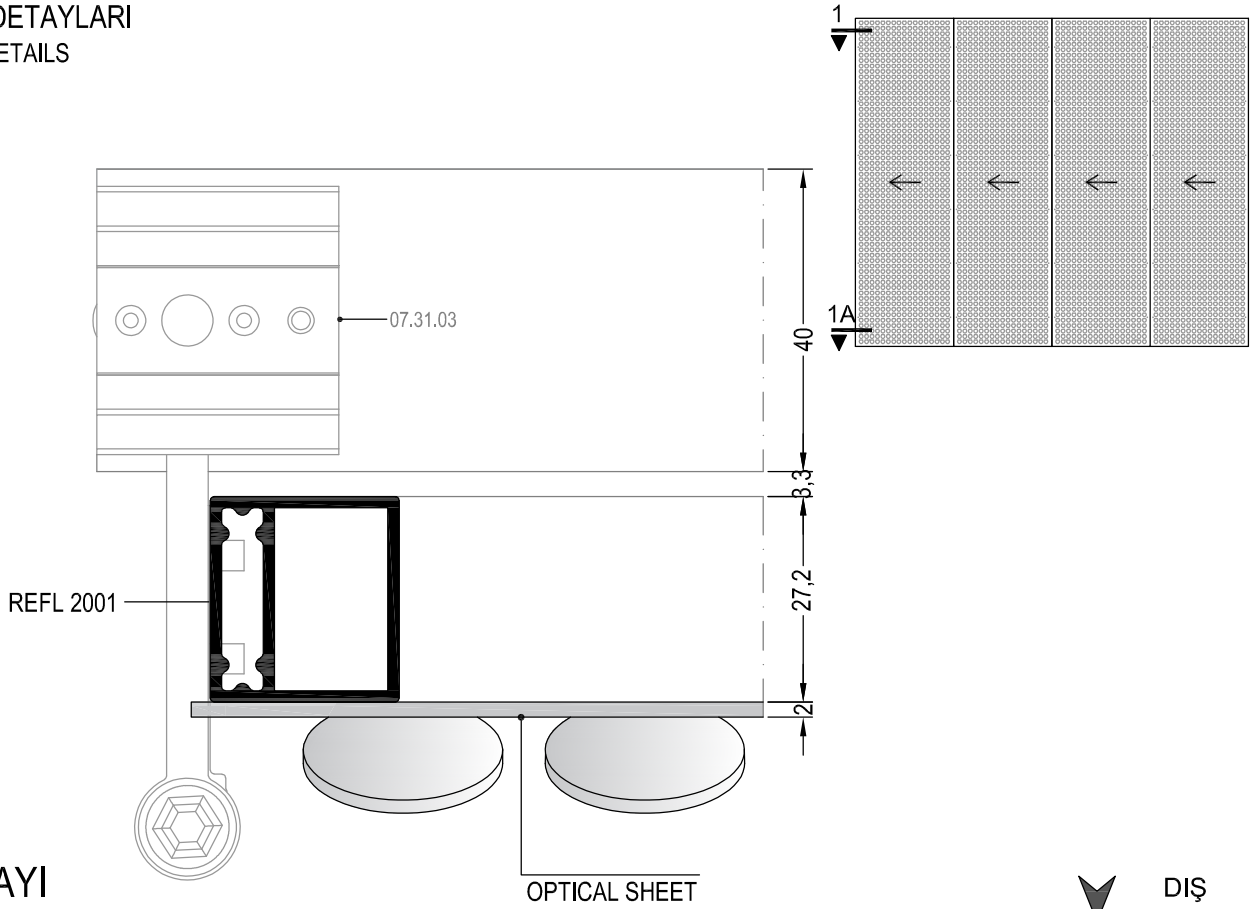

① DETAYI
DETAIL

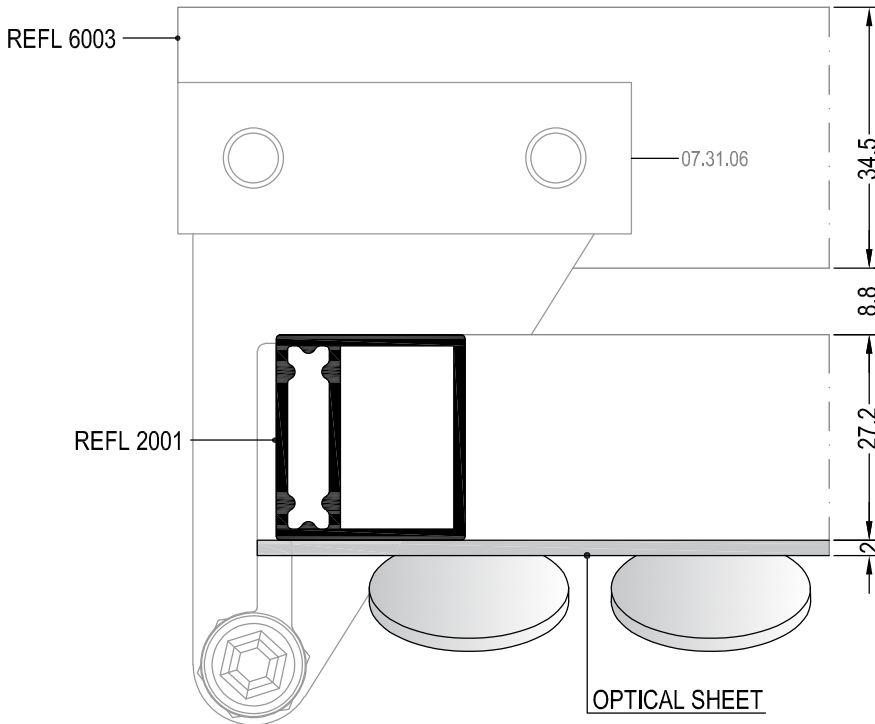

①A DETAYI
DETAIL

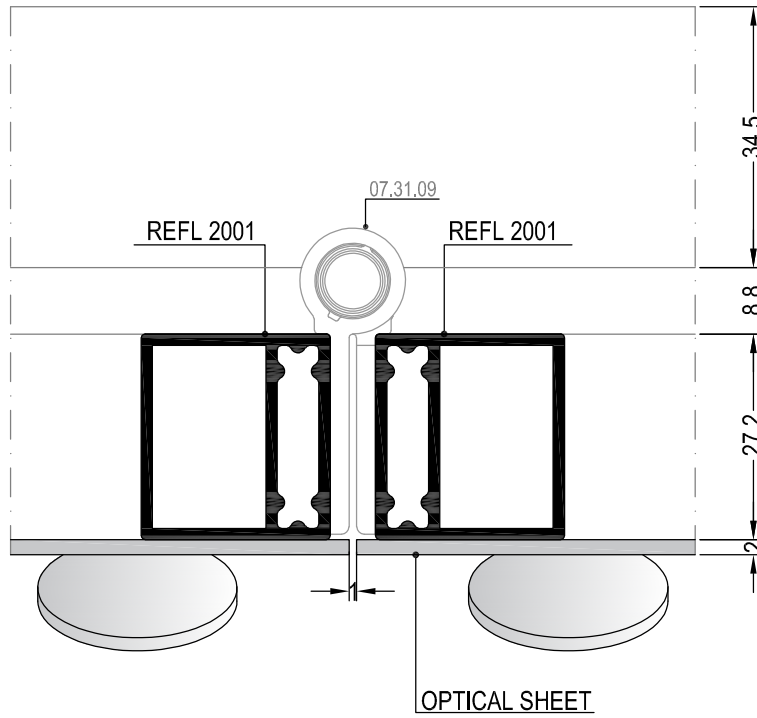
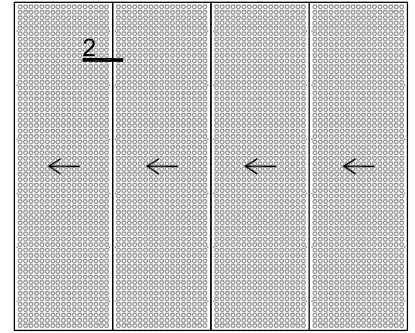

② DETAYI
DETAIL

DIŞ
(OUTSIDE)

SİSTEM DETAYLARI
SYSTEM DETAILS

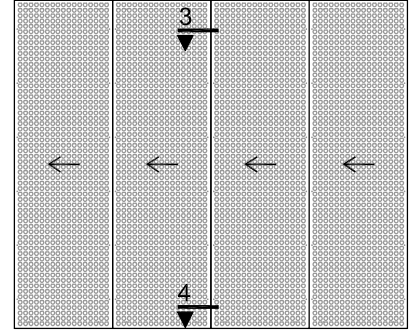
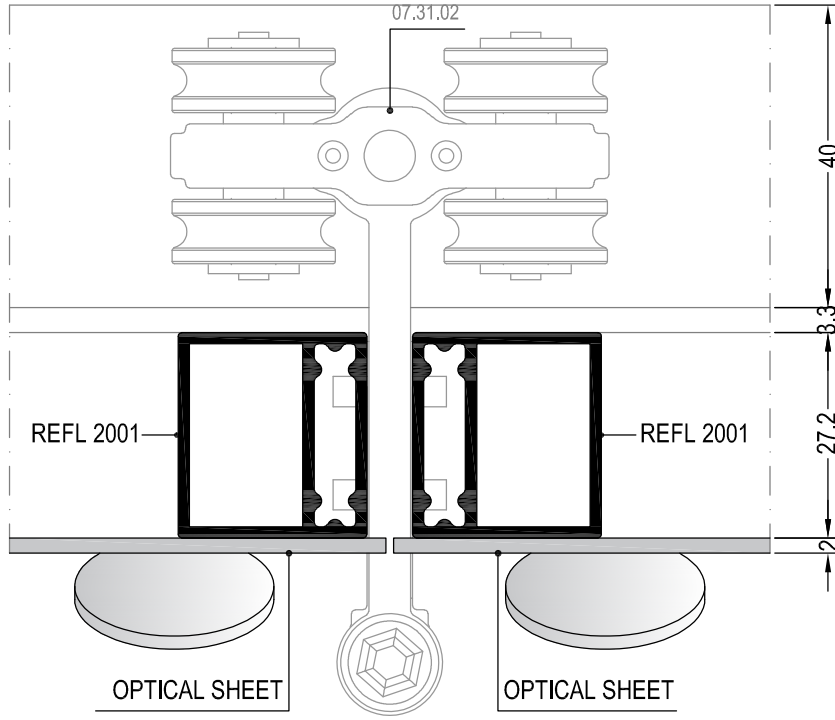

③ DETAYI
DETAIL

DIŞ
(OUTSIDE)

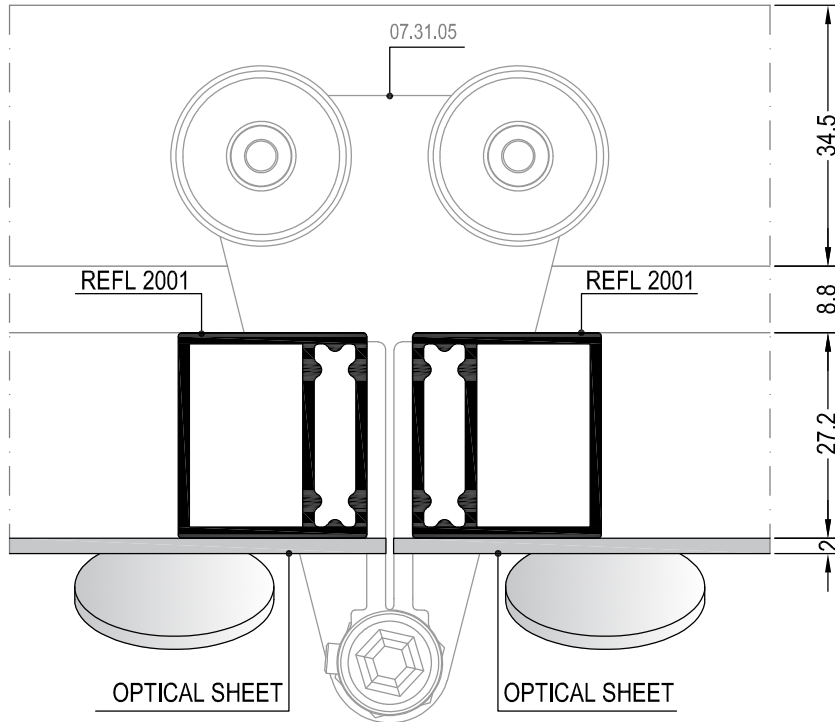

④ DETAYI
DETAIL

DIŞ
(OUTSIDE)

SİSTEM DETAYLARI
SYSTEM DETAILS

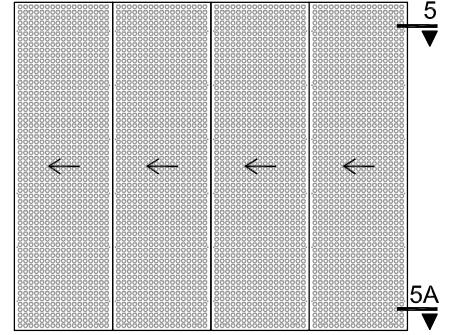
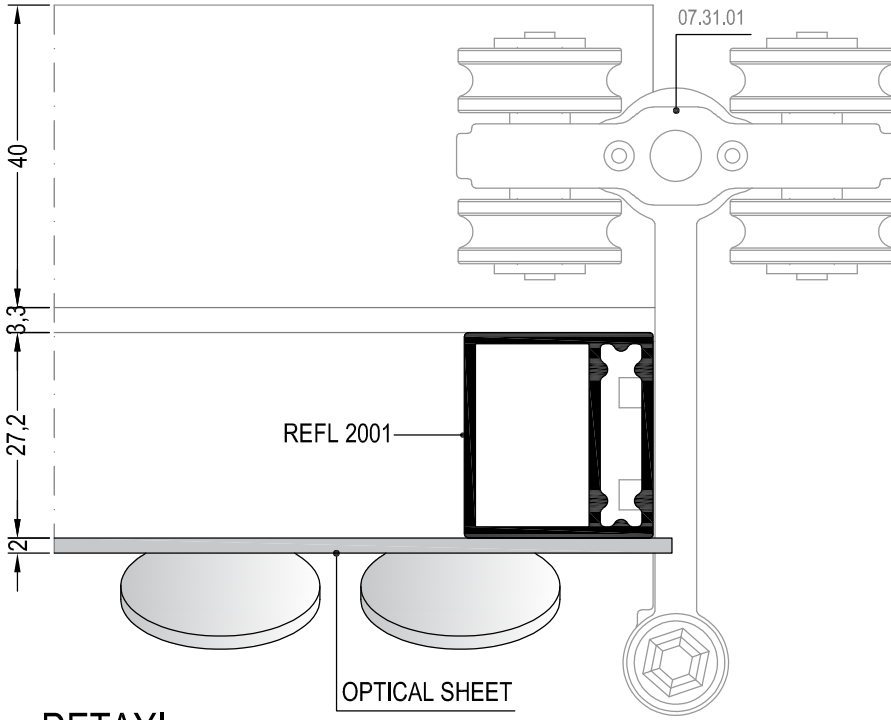

5 DETAYI
DETAIL

DIŞ
(OUTSIDE)

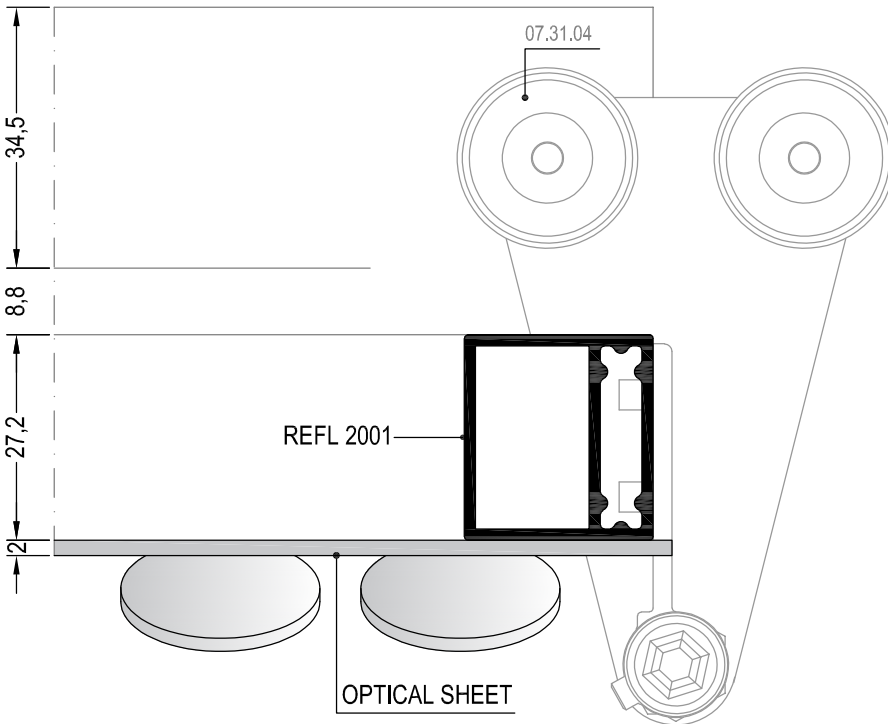

5A DETAYI
DETAIL

DIŞ
(OUTSIDE)

SİSTEM DETAYLARI
SYSTEM DETAILS

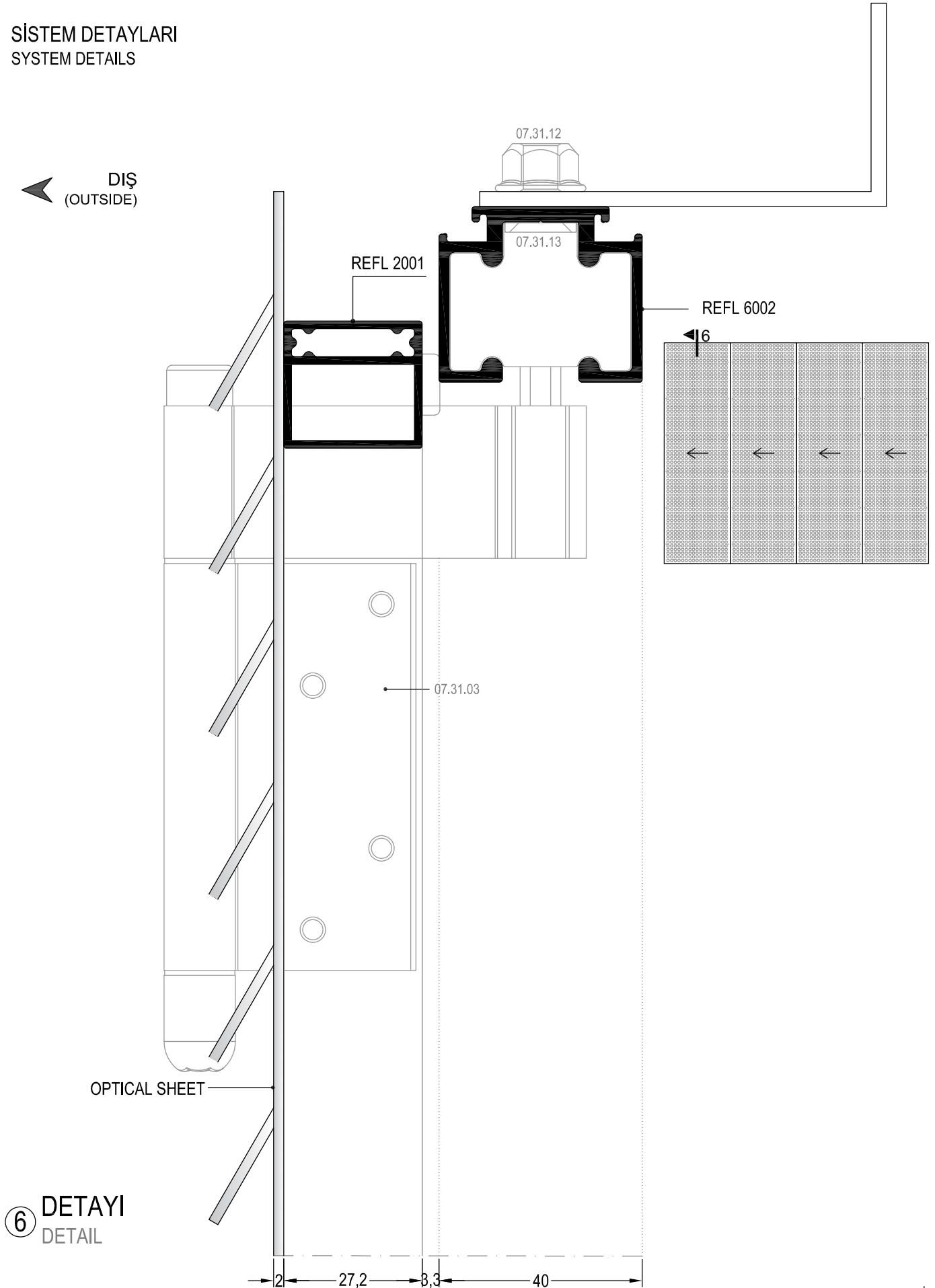

SİSTEM DETAYLARI
SYSTEM DETAILS

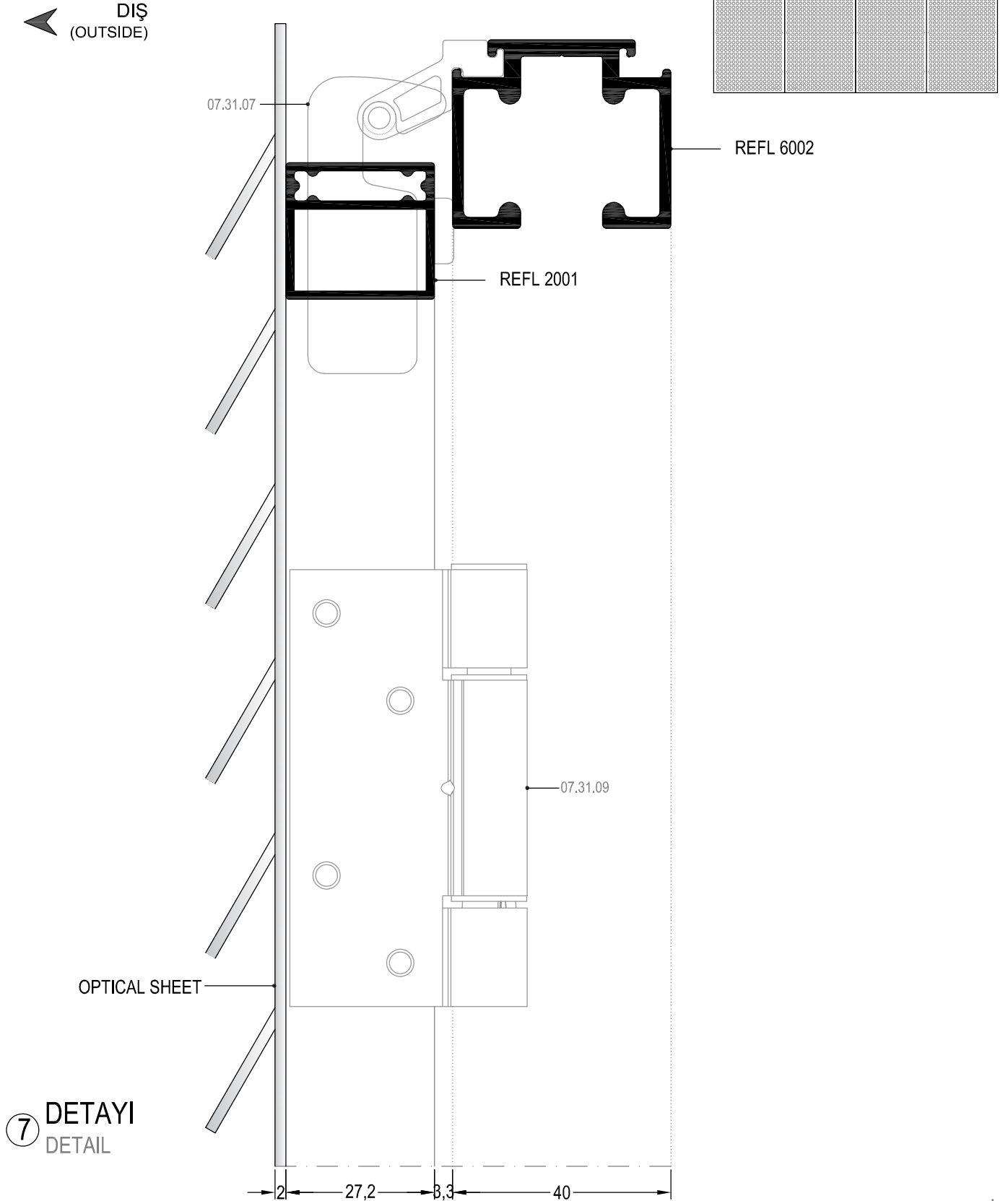

SİSTEM DETAYLARI
SYSTEM DETAILS

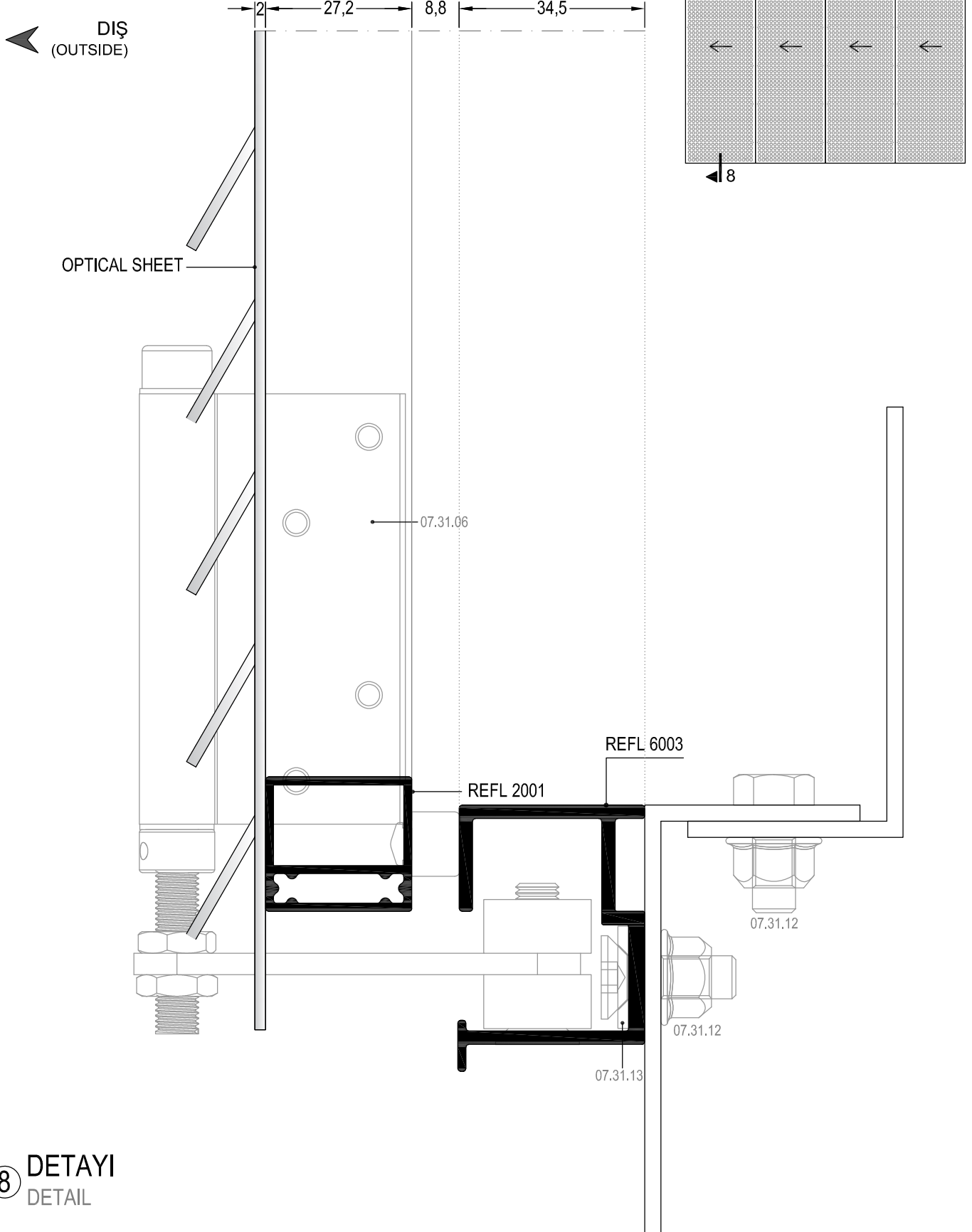

8 DETAYI
DETAIL

SİSTEM DETAYLARI
SYSTEM DETAILS

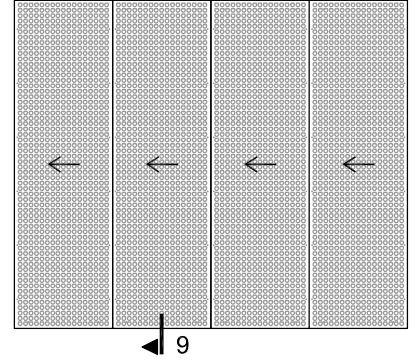
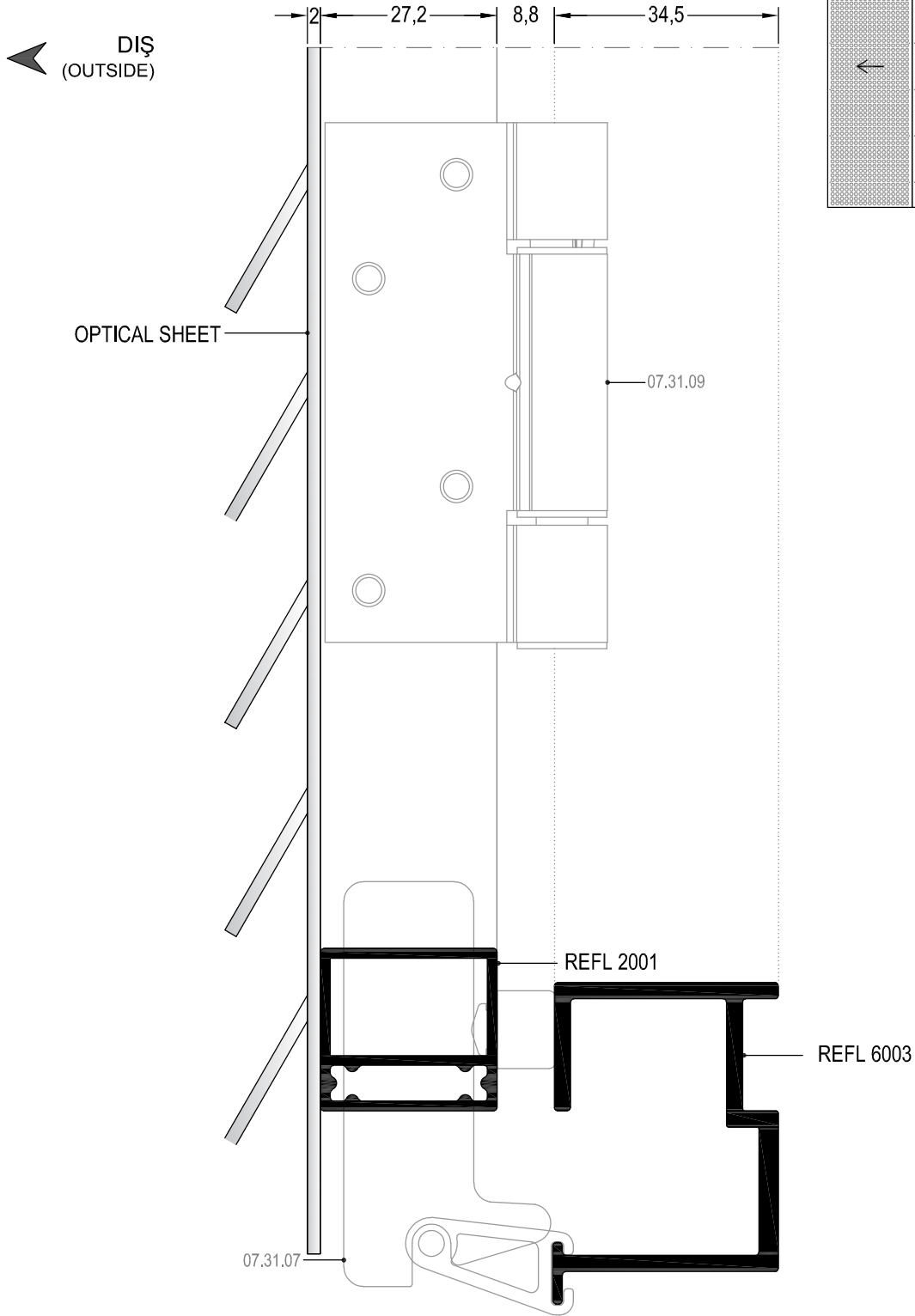

9 DETAYI
DETAIL

SİSTEM DETAYLARI
SYSTEM DETAILS

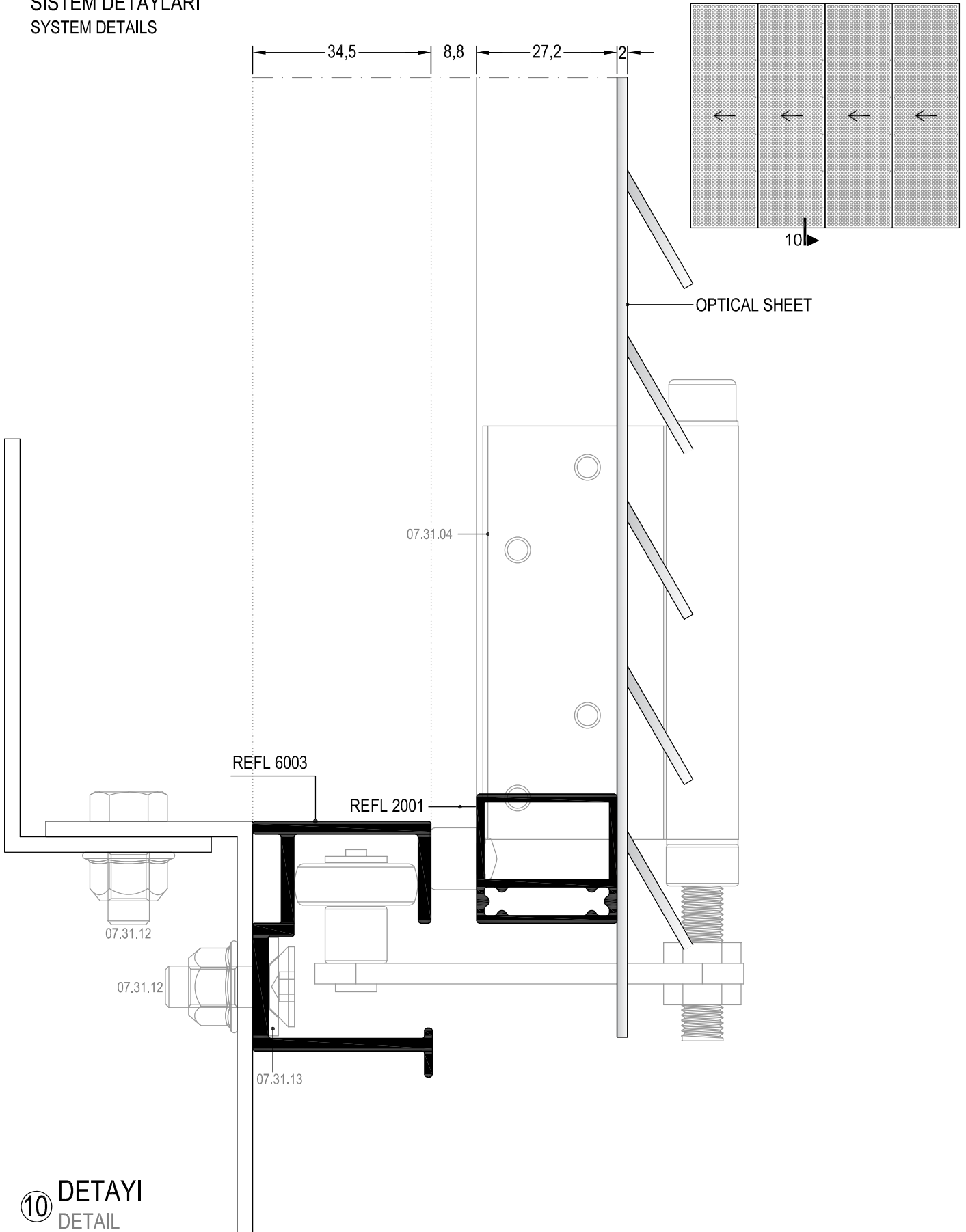

⑩ DETAYI
DETAIL

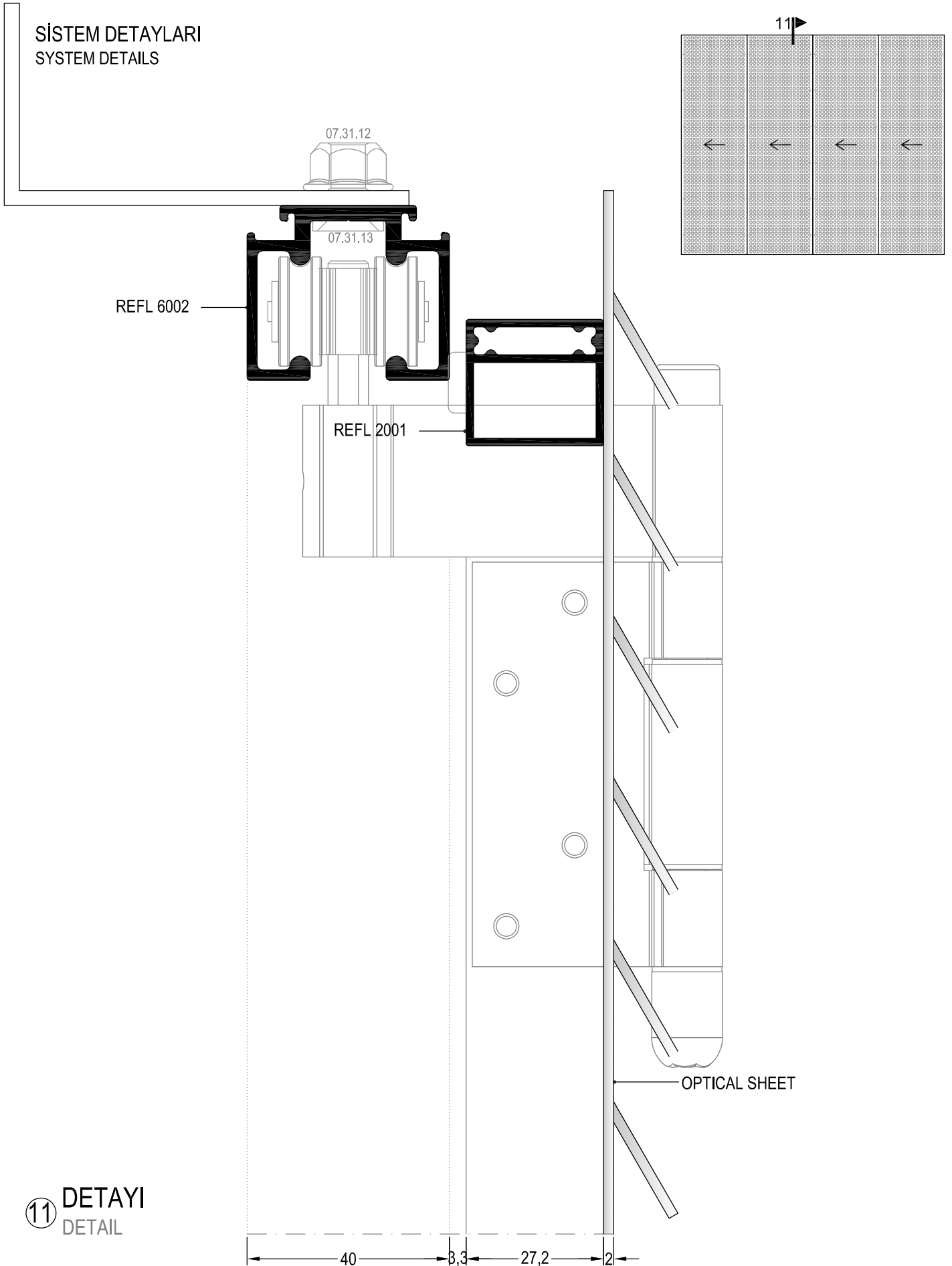

11 DETAYI
DETAIL

SİSTEM DETAYLARI
SYSTEM DETAILS

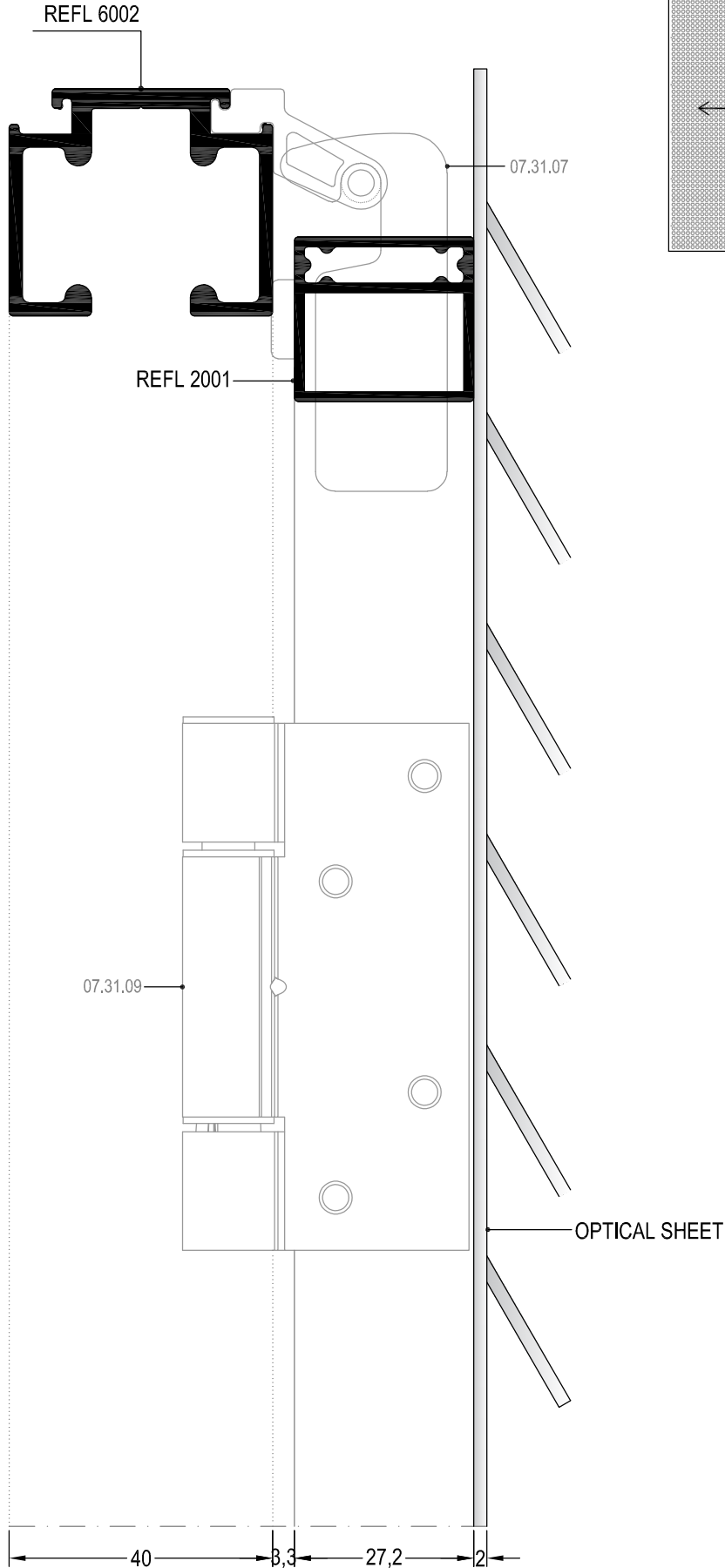

12 DETAYI
DETAIL

DIŞ
(OUTSIDE) ➔

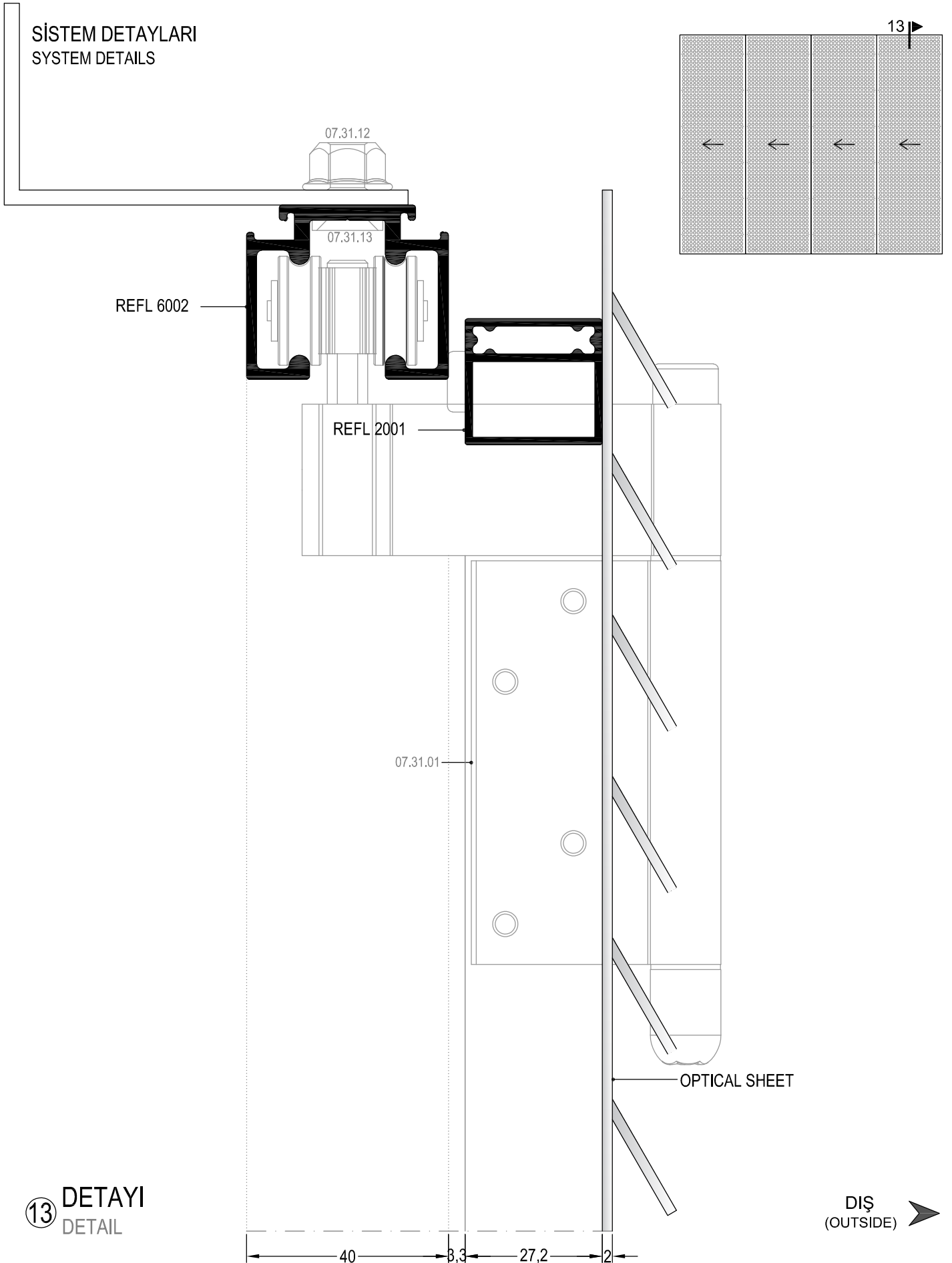

SİSTEM DETAYLARI
SYSTEM DETAILS

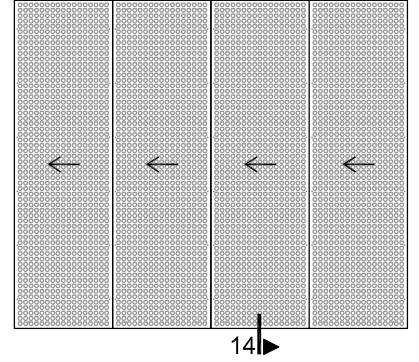
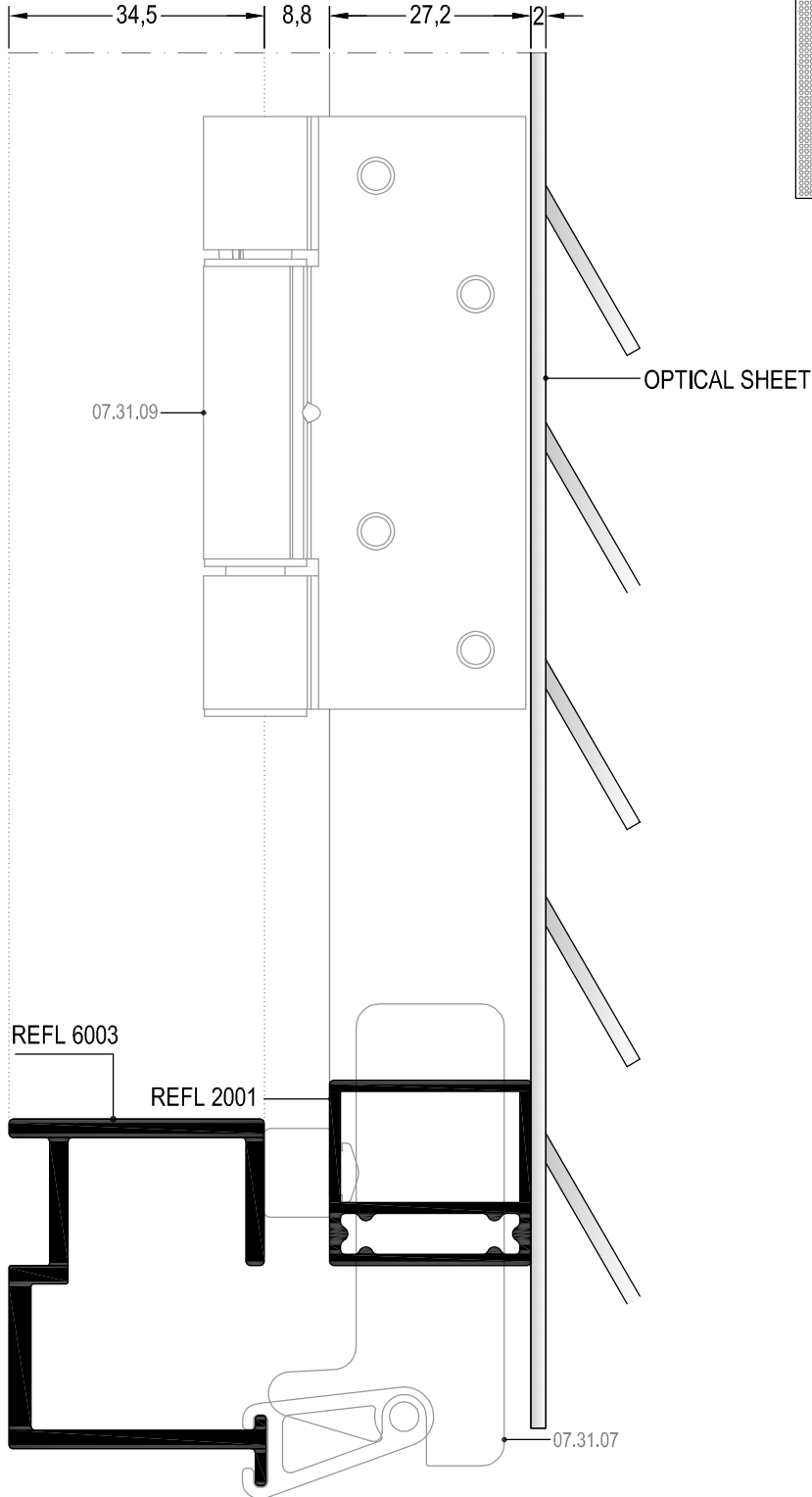

14 DETAYI
DETAIL

DIŞ
(OUTSIDE) ➔

SİSTEM DETAYLARI
SYSTEM DETAILS

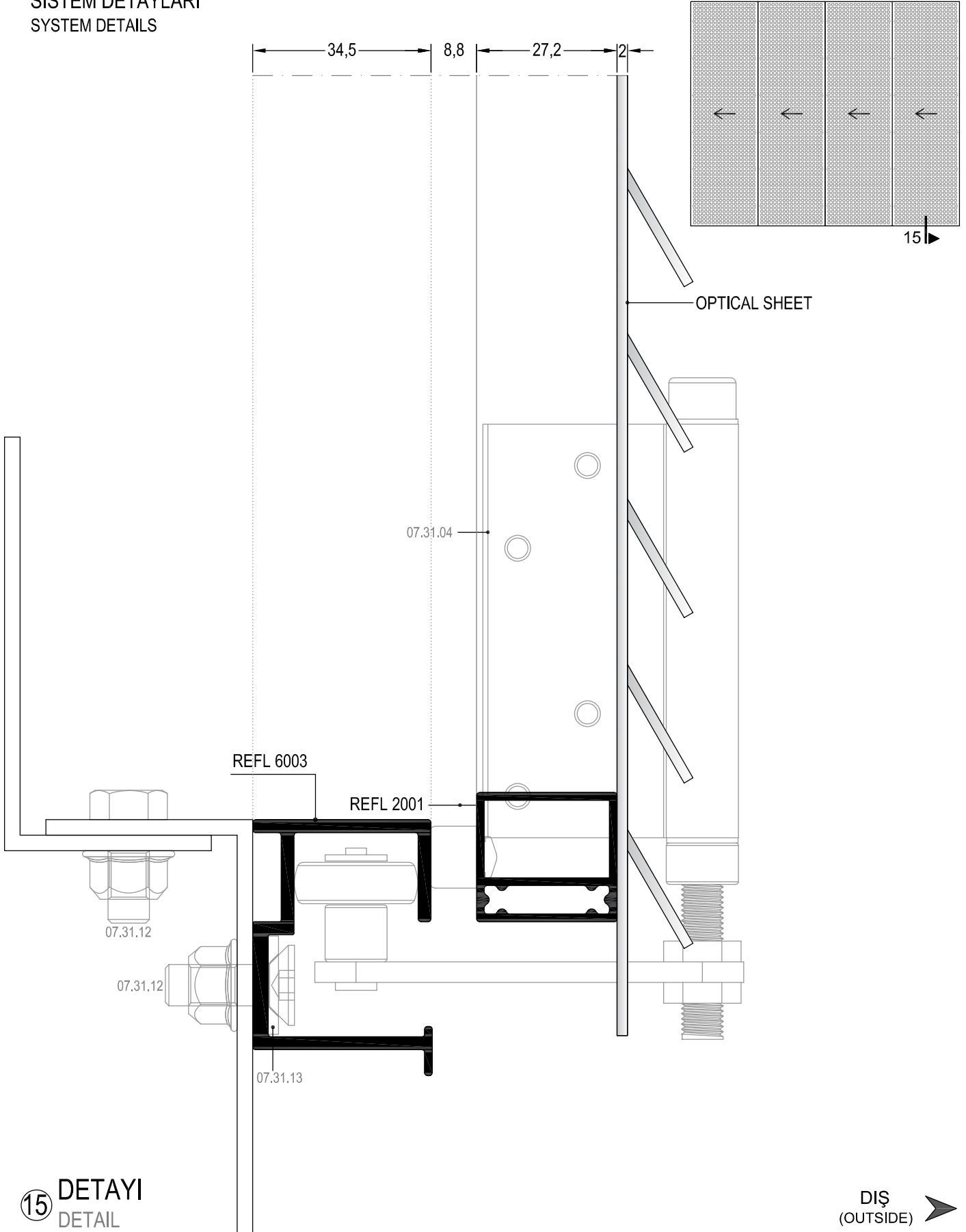

15 DETAYI
DETAIL

DIŞ
(OUTSIDE) ➔

SİSTEM DETAYLARI
SYSTEM DETAILS

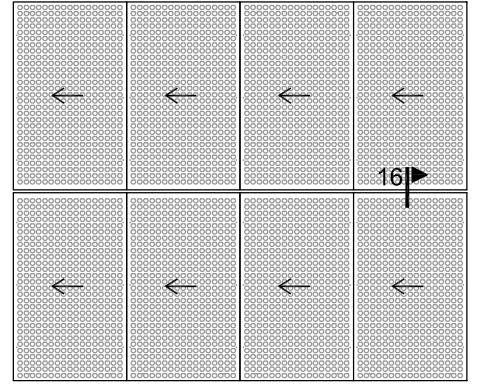
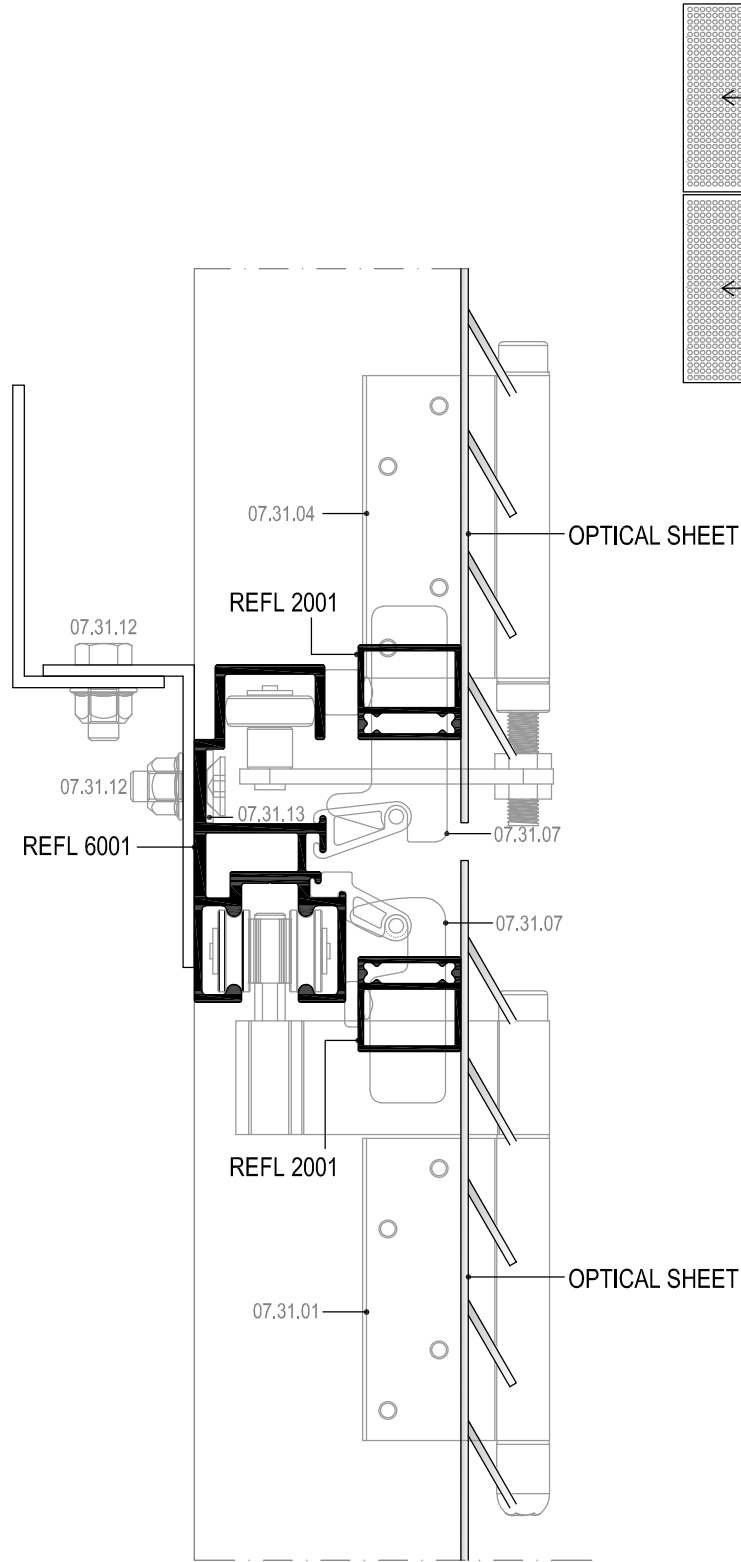

ÖLÇEK :1/2
SCALE

16 DETAYI
DETAIL

DIŞ
(OUTSIDE) ➔

SİSTEM DETAYLARI
SYSTEM DETAILS

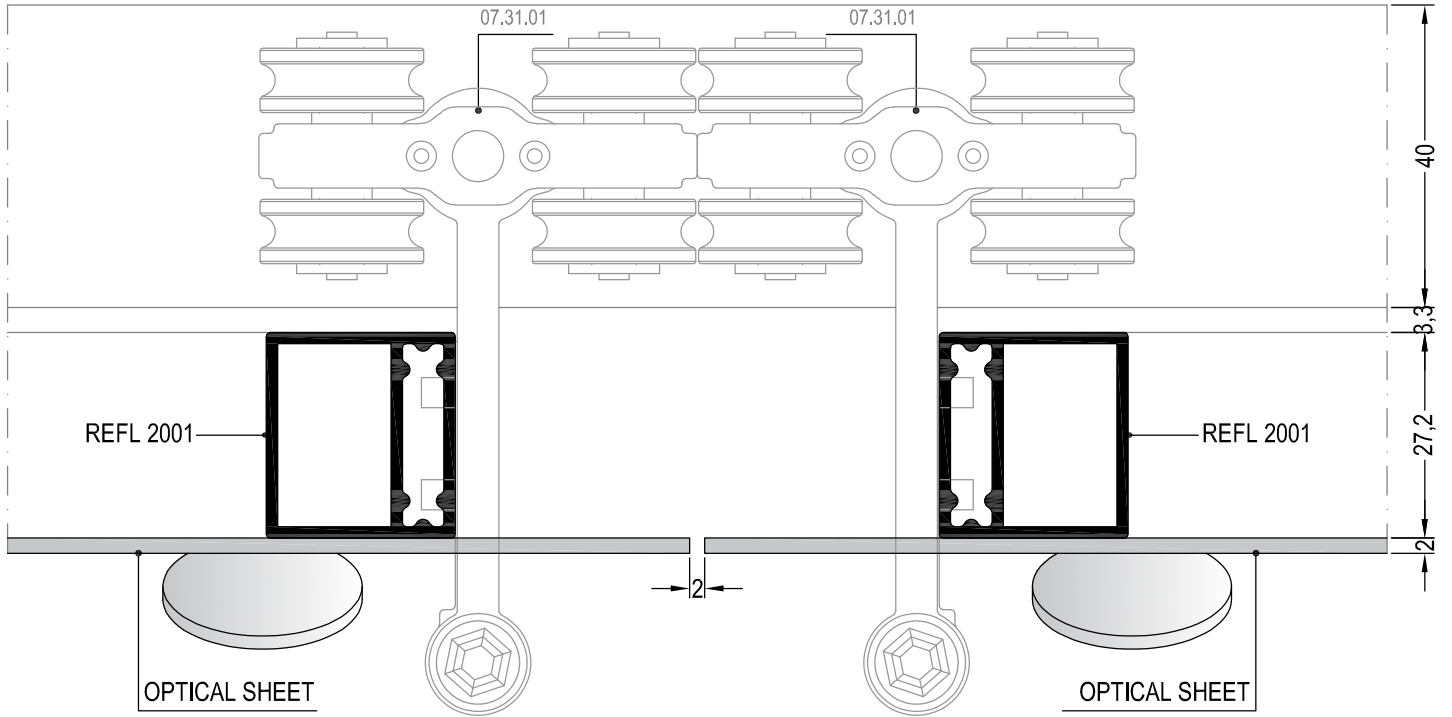
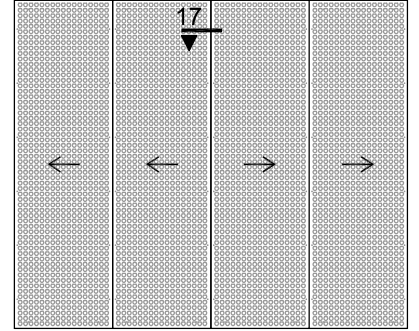

17 DETAYI
DETAIL

DIŞ
(OUTSIDE) ➔

SİSTEM DETAYLARI
SYSTEM DETAILS

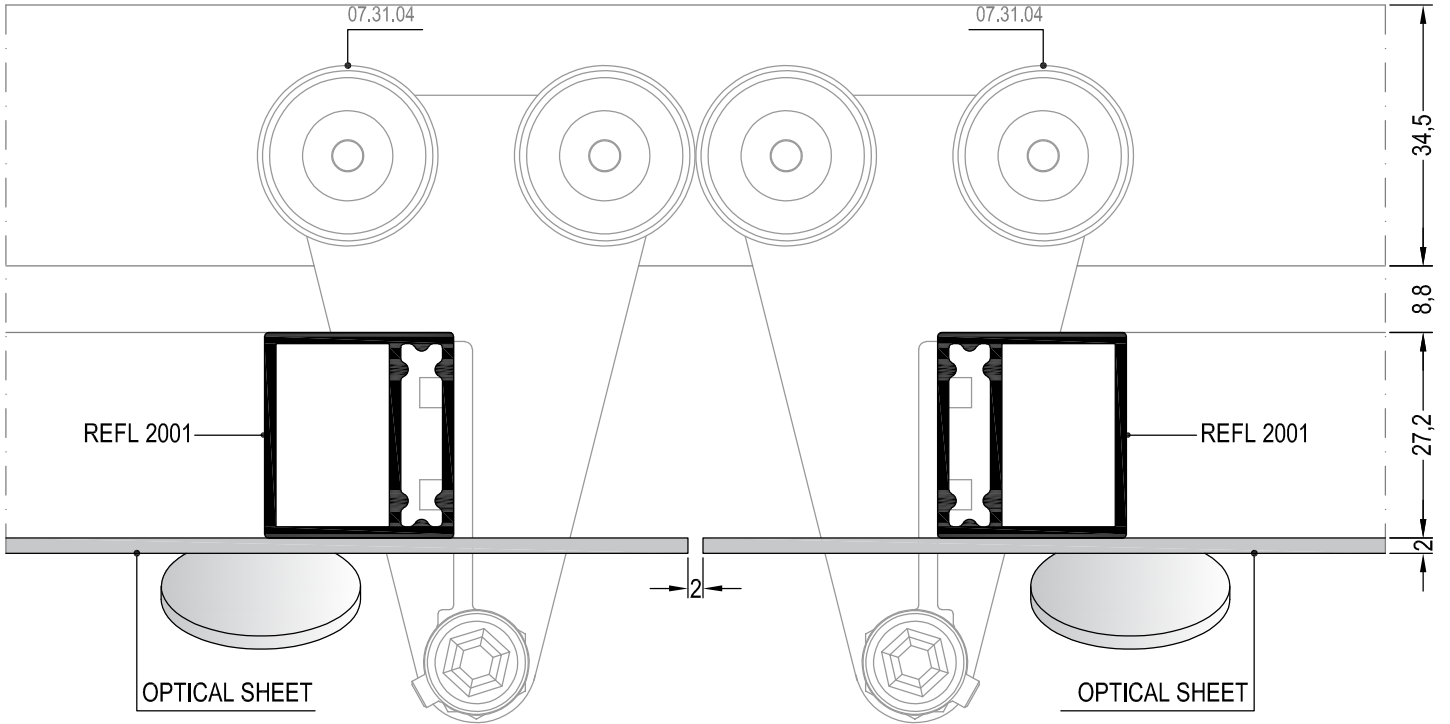
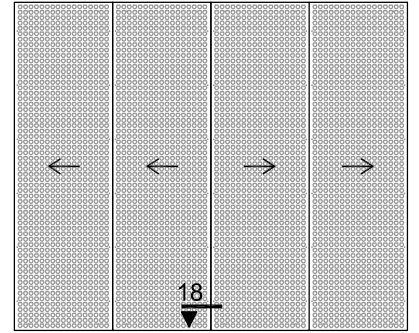

18 DETAYI
DETAIL

DIŞ
(OUTSIDE) ➔

MİMARİ KATALOG
ARCHITECTURAL CATALOGUE

Alüminyum Kapı Pencere ve Giydirme Cephe Sistemleri
Aluminium Window Doors and Facade Systems



REFL40

AKSESUARLAR

ACCESSORIES

07.31.01

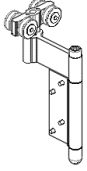

ÜST KAFA ARABA
TOP END ROLLER

07.31.02

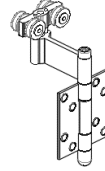

ÜST ORTA ARABA
TOP CENTRAL ROLLER

07.31.03

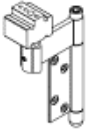

ÜST SABİT TAKOZ
TOP GUIDE

07.31.04

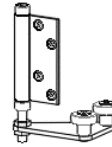

ALT KAFA ARABA
BOTTOM END ROLLER

07.31.05

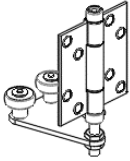

ALT ORTA ARABA
BOTTOM CENTRAL ROLLER

07.31.06

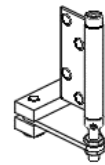

ALT SABİT KILAVUZ
BOTTOM GUIDE

07.31.07

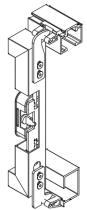

MEKANİK KİLİT SETİ VE TAMPONLAR
MECHANICAL LOCK SET AND BUFFERS

07.31.09

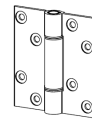

YAPRAK MENTEŞE
LEAF HINGE

07.31.10

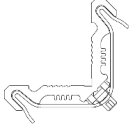

ÇEKTİRMELİ KÖŞE TAKOZU
EXTRUDED CORNER JOINT WITH STEEL COVER

07.31.11

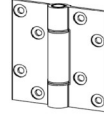

YAPRAK MENTEŞE (ARABA HIZASI)
LEAF HINGE (LEVEL OF ROLLER)

07.31.12

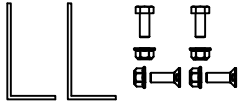

ANKRAJ TAKIMI
BOLTING SET

07.31.13

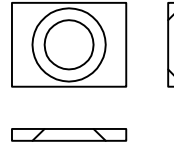

KÖŞELİ PUL
ANGLED WASHER

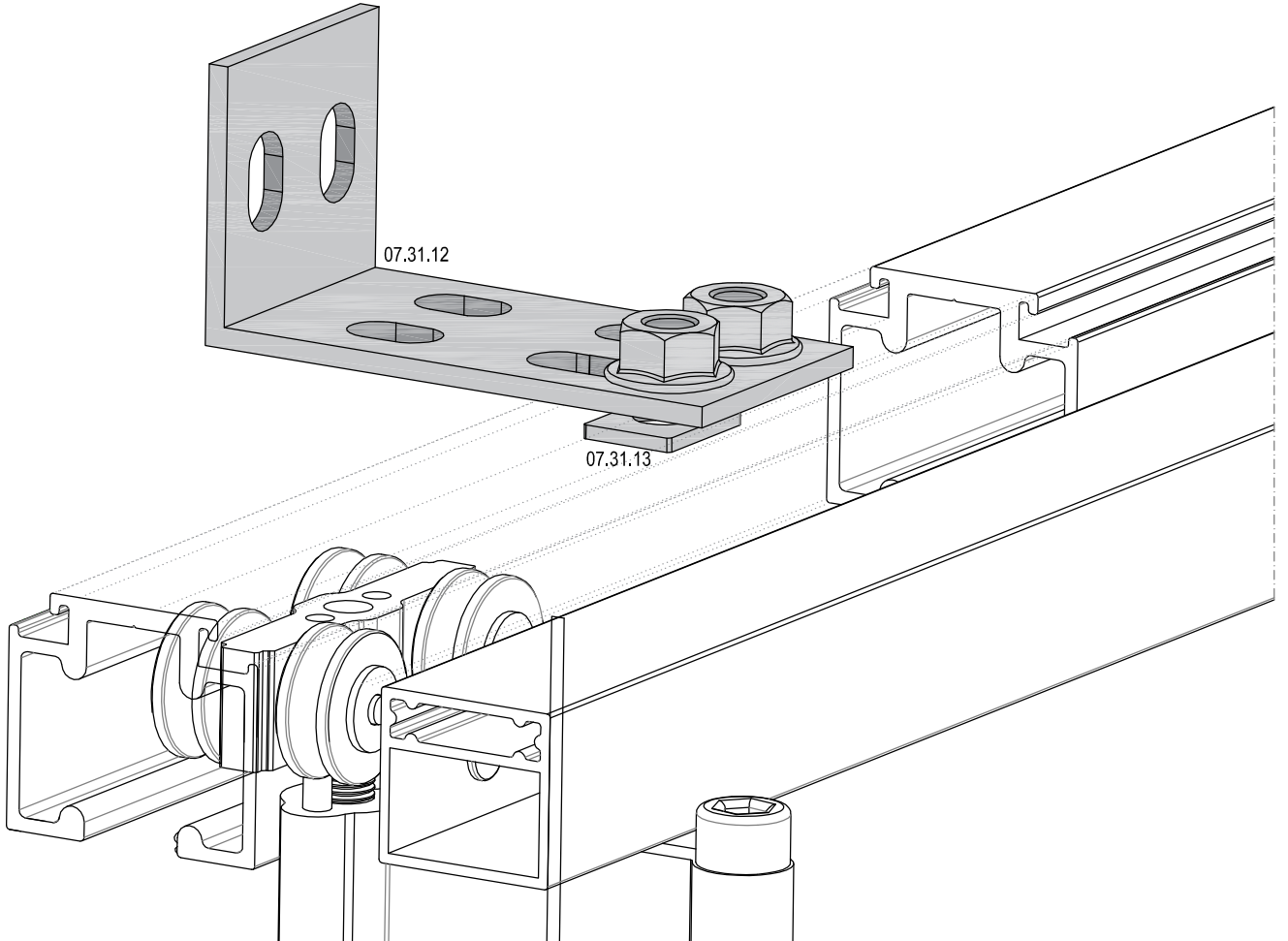

AKSESUAR DETAYLARI
ACCESSORY DETAILS

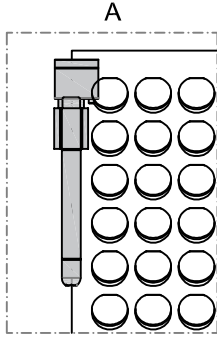

07.31.03
ÜST SABİT TAKOZ
TOP GUIDE

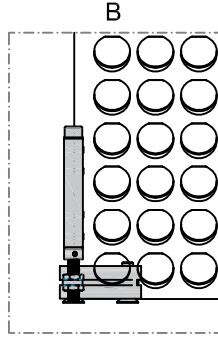

07.31.06
ALT SABİT KILAVUZ
BOTTOM GUIDE

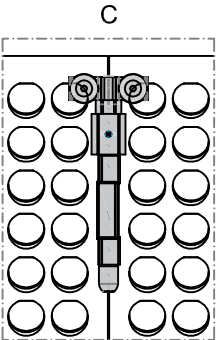
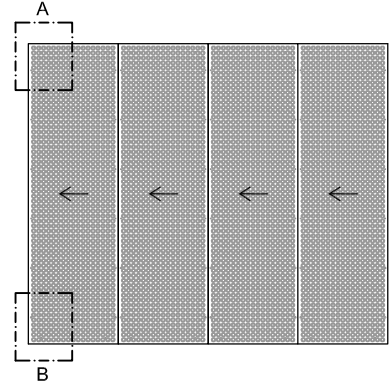

07.31.02
ÜST ORTA ARABA
TOP CENTRAL ROLLER

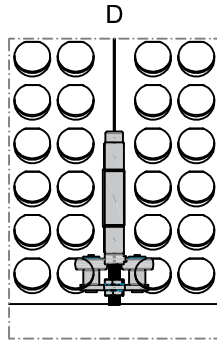

07.31.05
ALT ORTA ARABA
BOTTOM CENTRAL ROLLER

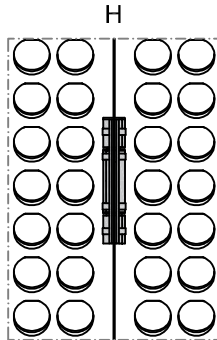

07.31.11
YAPRAK MENTEŞE (ARABA HIZASI)
LEAF HINGE (LEVEL OF ROLLER)

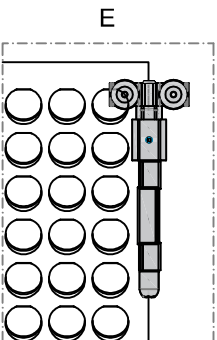
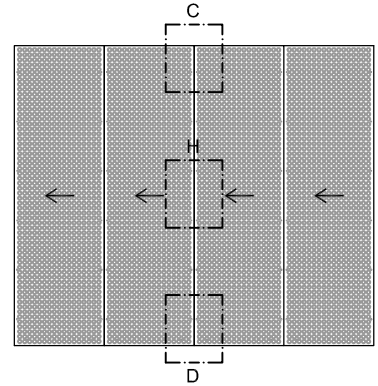

07.31.01
ÜST KAFA ARABA
TOP END ROLLER

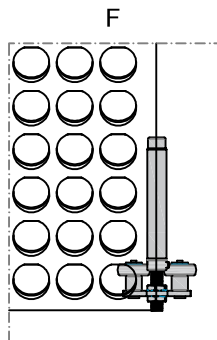



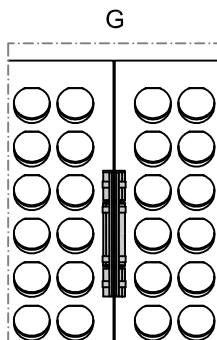

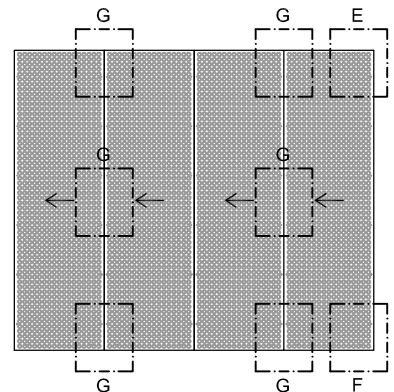

07.31.04
ALT KAFA ARABA
BOTTOM END ROLLER



07.31.09
YAPRAK MENTEŞE
LEAF HINGE









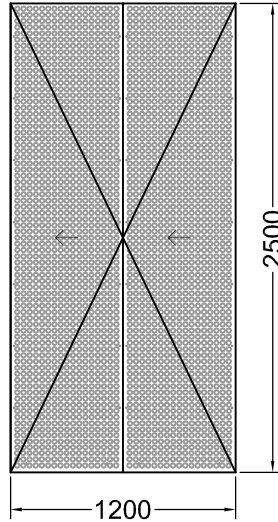



FS01 TİP İÇİN AKSESUAR SEÇİM TABLOSU
ACCESSORIES SELECTION TABLE FOR FS01 TYPE

ÜRÜN RESMİ PRODUCT IMAGE	KOD CODE	TANIM DESCRIPTION	ADET PIECE
	07.31.03	ÜST SABİT TAKOZ TOP GUIDE	1
	07.31.06	ALT SABİT KILAVUZ BOTTOM GUIDE	1
	07.31.01	ÜST KAFA ARABA TOP END ROLLER	1
	07.31.04	ALT KAFA ARABA BOTTOM END ROLLER	1
	07.31.09	YAPRAK MENTEŞE LEAF HINGE	3
	07.31.07	MEKANİK KİLİT SETİ VE TAMPONLAR MECHANICAL LOCK SET AND BUFFERS	1
	07.31.10	ÇEKTİRMELİ KÖŞE TAKOZU EXTRUDED CORNER JOINT WITH STEEL COVER	8

FS01









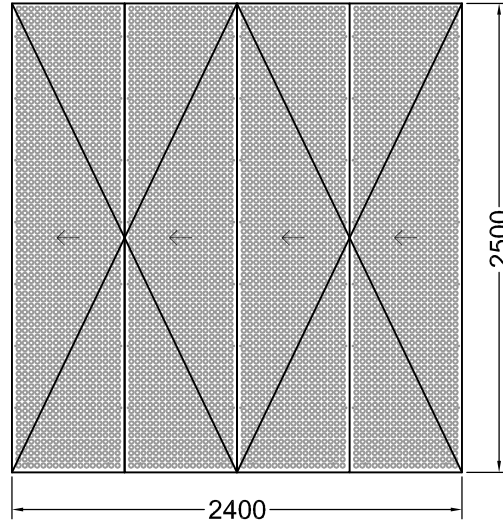



FS02 TİP İÇİN AKSESUAR SEÇİM TABLOSU
ACCESSORIES SELECTION TABLE FOR FS02 TYPE

ÜRÜN RESMİ PRODUCT IMAGE	KOD CODE	TANIM DESCRIPTION	ADET PIECE
	07.31.03	ÜST SABİT TAKOZ TOP GUIDE	1
	07.31.06	ALT SABİT KILAVUZ BOTTOM GUIDE	1
	07.31.01	ÜST KAFA ARABA TOP END ROLLER	1
	07.31.04	ALT KAFA ARABA BOTTOM END ROLLER	1
	07.31.02	ÜST ORTA ARABA TOP CENTRAL ROLLER	1
	07.31.05	ALT ORTA ARABA BOTTOM CENTRAL ROLLER	1
	07.31.09	YAPRAK MENTEŞE LEAF HINGE	6
	07.31.11	YAPRAK MENTEŞE (ARABA HİZASI) LEAF HINGE (ROLLER LEVEL)	1
	07.31.07	MEKANİK KİLİT SETİ VE TAMPONLAR MECHANICAL LOCK SET AND BUFFERS	2
	07.31.10	ÇEKTİRMELİ KÖŞE TAKOZU EXTRUDED CORNER JOINT WITH STEEL COVER	16

FS02







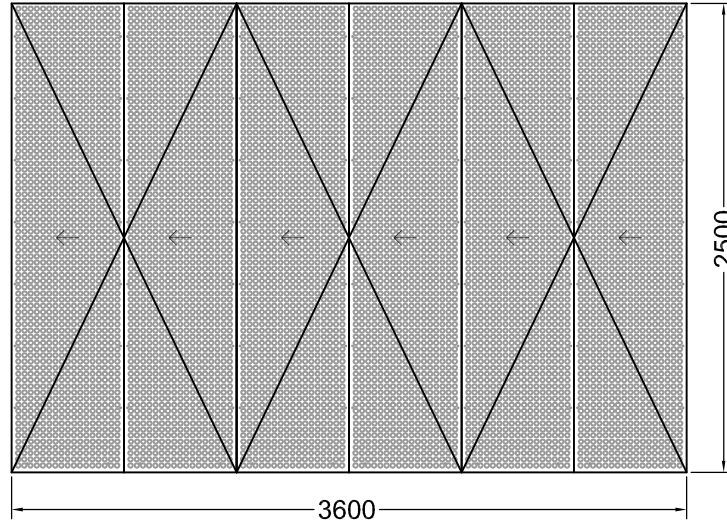

FS03 TİP İÇİN AKSESUAR SEÇİM TABLOSU
ACCESSORIES SELECTION TABLE FOR FS03 TYPE

ÜRÜN RESMİ PRODUCT IMAGE	KOD CODE	TANIM DESCRIPTION	ADET PIECE
	07.31.03	ÜST SABİT TAKOZ TOP GUIDE	1
	07.31.06	ALT SABİT KILAVUZ BOTTOM GUIDE	1
	07.31.01	ÜST KAFA ARABA TOP END ROLLER	1
	07.31.04	ALT KAFA ARABA BOTTOM END ROLLER	1
	07.31.02	ÜST ORTA ARABA TOP CENTRAL ROLLER	2
	07.31.05	ALT ORTA ARABA BOTTOM CENTRAL ROLLER	2
	07.31.09	YAPRAK MENTEŞE LEAF HINGE	9
	07.31.11	YAPRAK MENTEŞE (ARABA HİZASI) LEAF HINGE (ROLLER LEVEL)	2
	07.31.07	MEKANİK KİLİT SETİ VE TAMPONLAR MECHANICAL LOCK SET AND BUFFERS	3
	07.31.10	ÇEKTİRMELİ KÖŞE TAKOZU EXTRUDED CORNER JOINT WITH STEEL COVER	24

FS03



FS04 TİP İÇİN AKSESUAR SEÇİM TABLOSU
ACCESSORIES SELECTION TABLE FOR FS03 TYPE

ÜRÜN RESMİ PRODUCT IMAGE	KOD CODE	TANIM DESCRIPTION	ADET PIECE
	07.31.03	ÜST SABİT TAKOZ TOP GUIDE	2
	07.31.06	ALT SABİT KILAVUZ BOTTOM GUIDE	2
	07.31.01	ÜST KAFA ARABA TOP END ROLLER	2
	07.31.04	ALT KAFA ARABA BOTTOM END ROLLER	2
	07.31.09	YAPRAK MENTEŞE LEAF HINGE	6
	07.31.07	MEKANİK KİLİT SETİ VE TAMPONLAR MECHANICAL LOCK SET AND BUFFERS	2
	07.31.10	ÇEKTİRMELİ KÖŞE TAKOZU EXTRUDED CORNER JOINT WITH STEEL COVER	16

FS04

